

09/13

1. AUSGABE 2013



**HO TENDERLOK REIHE 178** der BBÖ

**HO SCHNELLZUGLOK BR 19.10** der DRG

**HO DIESELLOK V 100** der DB Bahnbau und «Lisa2» der EIB

**HO BIERWAGEN** «Dortmunder Union» der DB und «Schwechater Bier» der BBÖ

**HO GEDECKTER GÜTERWAGEN GL** «Miele» der DB

**HO KESSELWAGEN** «Esso» der SJ

**HO KESSELWAGEN** «VITA Kraftfutter» der DB und «ARAL» der DR (Brit. US-Zone)

**HO NEUBAUKESSELWAGEN** «Minol» der DR

**N SPEISEWAGEN WRGE UND WRGE STÄDTEEXPRESS** der DR (Rekowagen)

**N STEUERWAGEN BYBDZF 482.1** der DB Regio (Wittenberger Kopf)

**N EINHEITSWAGEN A UND B EW II** der SBB

**BRAWA**

LIEBE ZUM DETAIL



## TENDERLOK REIHE 178 DER BBÖ



		Best.-Nr. <b>40636</b> UVP* 284,90 EUR			Best.-Nr. <b>40637</b> UVP* 314,90 EUR					
		Best.-Nr. <b>40638</b> UVP* 424,90 EUR			Best.-Nr. <b>40639</b> UVP* 424,90 EUR					
										Betriebs-Nr. 92 2269

Liefertermin: sofort lieferbar

- Sicherheitsventile in Fahrtrichtung
- Kurzer Wassertank links
- Kessel, Wasserkästen, Chassis und Räder aus Zinkdruckguss
- Einzeln angesetzte Griffstangen aus Metall, bzw. schlagzähem Kunststoff
- Feinste Bedruckung und Lackierung
- Rauchgenerator eingebaut, bzw. für Einbau vorbereitet
- Epochengerechte Beleuchtung, mehrteilige Lampengehäuse
- Filigrane Steuerung
- Wechselstrom im Analogbetrieb: Fahrtrichtungswechsel nicht möglich

\*

# SCHNELLZUGLOK BR 19.10 DER DRG



			Best.-Nr. <b>40142</b> UVP* 334,90 EUR				Best.-Nr. <b>40143</b> UVP* 364,90 EUR
			Best.-Nr. <b>40144</b> UVP* 474,90 EUR				Best.-Nr. <b>40145</b> UVP* 474,90 EUR
		271,4	Rmin 360		2		Betriebs-Nr. 19 1001



Liefertermin: sofort lieferbar

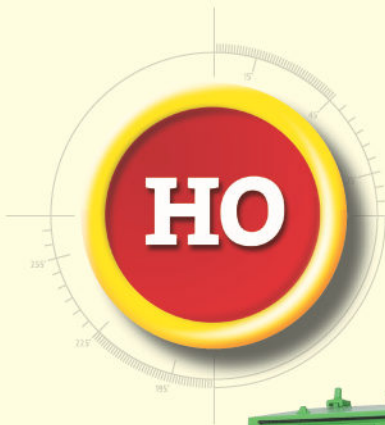

- Federpuffer am Tender
- Frei stehende Führungsschienen für Kohlekastendeckel
- Tenderabstand variabel einstellbar
- Frei stehende Leitern in geringer Materialstärke
- Chassis, Räder und Gehäuse aus Zinkdruckguss
- Antrieb in der Lok auf alle vier Achsen
- Originalgetreue Nachbildung der Bremsbacken und Bremsgestänge an der Unterseite der Lok
- Metallspeichenräder
- Vorbildgerechte, 3-teilige Windleitbleche
- Lackierung in „Stahlblau“







# DIESELLOK V 100 „LISA“ DER ERFURTER INDUSTRIEBAHN



		Best.-Nr. <b>41248</b> UVP* 149,90 EUR			Best.-Nr. <b>41249</b> UVP* 179,90 EUR
		Best.-Nr. <b>41250</b> UVP* 269,90 EUR			Best.-Nr. <b>41251</b> UVP* 269,90 EUR





 Betriebs-Nr. 95 80 3293 025-3

















- Getriebe aus Metall
- LED-Beleuchtung
- 21-polige Schnittstelle
- Für Sound vorbereitet bzw. eingebaut
- Filigrane Griffstangen
- Lupenreine Bedruckung
- Fein gravierte Lüftergitter
- Vorbildgerechte Detaillierung und Gravuren
- Mehrteilige Drehgestelle

Liefertermin: sofort lieferbar

\*

# DIESELLOK V 100 DER DB BAHNBAU



		Best.-Nr. <b>41256</b> UVP* 149,90 EUR			Best.-Nr. <b>41257</b> UVP* 179,90 EUR			
		Best.-Nr. <b>41258</b> UVP* 269,90 EUR			Best.-Nr. <b>41259</b> UVP* 269,90 EUR			
								Betriebs-Nr. 203 312-4

Liefertermin: sofort lieferbar

- Getriebe aus Metall
- LED-Beleuchtung
- 21-polige Schnittstelle
- Für Sound vorbereitet bzw. eingebaut
- Filigrane Griffstangen
- Lupenreine Bedruckung
- Fein gravierte Lüftergitter
- Vorbildgerechte Detaillierung und Gravuren
- Mehrteilige Drehgestelle



## ENDE DER DURSTSTRECKE FÜR BIERWAGENFANS



Bierwagen „Dortmunder Union Bier“ der DB

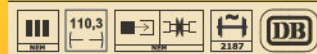

Best.-Nr. **48282**  
Betriebs-Nr. 504 271 P

Liefertermin: sofort lieferbar  
UVP\* 39,90 EUR

Bierwagen „Schwechater Bier“ der BBÖ

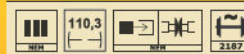

Best.-Nr. **48286**  
Betriebs-Nr. 560 050 P

Liefertermin: sofort lieferbar  
UVP\* 39,90 EUR

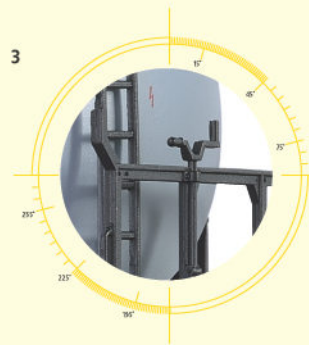
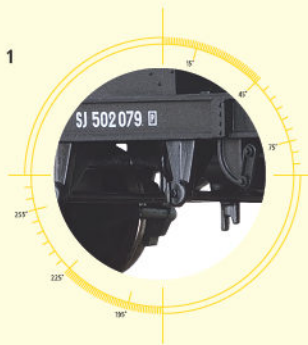

- 1\_Originalgetreu dargestelltes Fahrwerk
- 2\_Feinste Bedruckung und Lackierung
- 3\_Extra angesetzte Griffstangen

(Abbildungen zeigen Best.-Nr. 47079)



### Gedeckter Güterwagen Glr 22 „Miele“ der DB



Best.-Nr. **48702**  
Betriebs-Nr. 191 286

Liefertermin: sofort lieferbar  
UVP\* 39,90 EUR

### Kesselwagen "Esso" der SJ



Best.-Nr. **47079**  
Betriebs-Nr. 502 079 P

Liefertermin: sofort lieferbar  
UVP\* 29,90 EUR



# EIN KLASSIKER. MIT SUPER DETAILS



Kesselwagen "VITA Kraftfutter" der DB



Best.-Nr. **48859**  
Betriebs-Nr. 536 318 P

Liefertermin: sofort lieferbar  
UVP\* 28,50 EUR



Kesselwagen "Aral" der DR (Brit. US-Zone)



Best.-Nr. **48858**  
Betriebs-Nr. 503 015 P

Liefertermin: OKTOBER 2013  
UVP\* 28,50 EUR



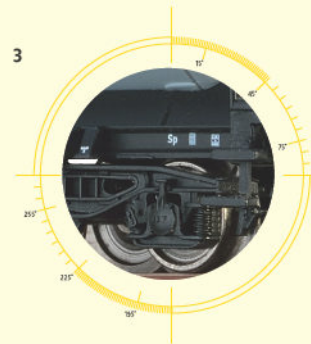
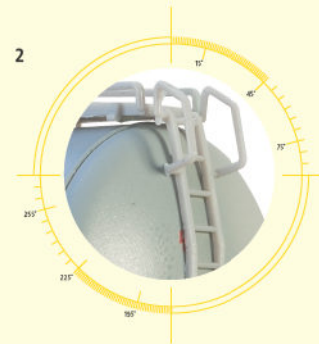

1\_Finste Bedruckung und Lackierung  
 2\_Extra angesetzte Griffstangen  
 3\_Originalgetreu dargestelltes Fahrwerk  
 (Abbildungen zeigen Best.-Nr. 48757)



**Neubaukesselwagen "Minol" der DR**

**Kühlwagen UIC-Standard 1 „STEF“ der SNCF**

	187,5			Best.-Nr. <b>48757</b>
				Betriebs-Nr. 31 50 785 2901-7

Liefertermin: sofort lieferbar  
 UVP\* 39,90 EUR

	135			Best.-Nr. <b>48313</b>
				Betriebs-Nr. 11 87 082 7068-1 P

Liefertermin: OKTOBER 2013  
 UVP\* 34,90 EUR



# DIE REKOWAGEN. DDR SCHNELLZUG-KLASSIKER



## Speisewagen WRge der DR (Rekowagen)

					Best.-Nr. <b>65057</b>
					Betriebs-Nr. 51 50 88-15 048-4

Liefertermin: sofort lieferbar  
UVP\* 44,90 EUR

## Speisewagen WRge Städteexpress der DR (Rekowagen)

					Best.-Nr. <b>65058</b>
					Betriebs-Nr. 51 50 88-15 038-5

Liefertermin: sofort lieferbar  
UVP\* 44,90 EUR



Best.-Nr. **65134**

### Steuerwagen Bybdzf 482.1 der DB Regio

Betriebs-Nr. 50 80 80-35 599-5

Liefertermin: sofort lieferbar

UVP\* 69,90 EUR

BETRIEBS-NR., ABWEICHEND



Best.-Nr. **65215**



### Einheitswagen A EW II der SBB

Betriebs-Nr. 50 85 18-33 616 -1

Liefertermin: sofort lieferbar

UVP\* 42,50 EUR

BETRIEBS-NR., ABWEICHEND

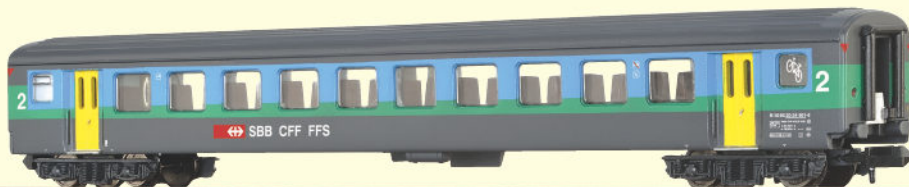

Best.-Nr. **65216**

Betriebs-Nr. 50 85 20-34 605-9



### Einheitswagen B EW II der SBB

Betriebs-Nr. siehe Best.-Nr.

Liefertermin: sofort lieferbar

UVP\* je 42,50 EUR



Best.-Nr. **65217**

Betriebs-Nr. 50 85 20-34 565-5



\*Unverbindliche Preisempfehlung (inkl. 19 % MwSt.), Preisänderungen vorbehalten.  
Konstruktions- oder Formänderungen, Abweichungen im Farbton bleiben vorbehalten.

Aral, DB AG, Dortmunder Union Bier, Erfurter Industriebahn, ESSO, Miele, Minol, SBB,  
Schwechater Bier und VITA Kraftfutter sind eingetragene Warenzeichen.

BRAWA Artur Braun Modellspielwarenfabrik GmbH + Co. · Uferstraße 26–28 · D-73630 Remshalden  
Hotline: Montag–Donnerstag 13.00 bis 15.00 Uhr +49 7151 97935-68  
Fax +49 7151 74662 · info@brawa.de · www.brawa.de

